

TWINNER

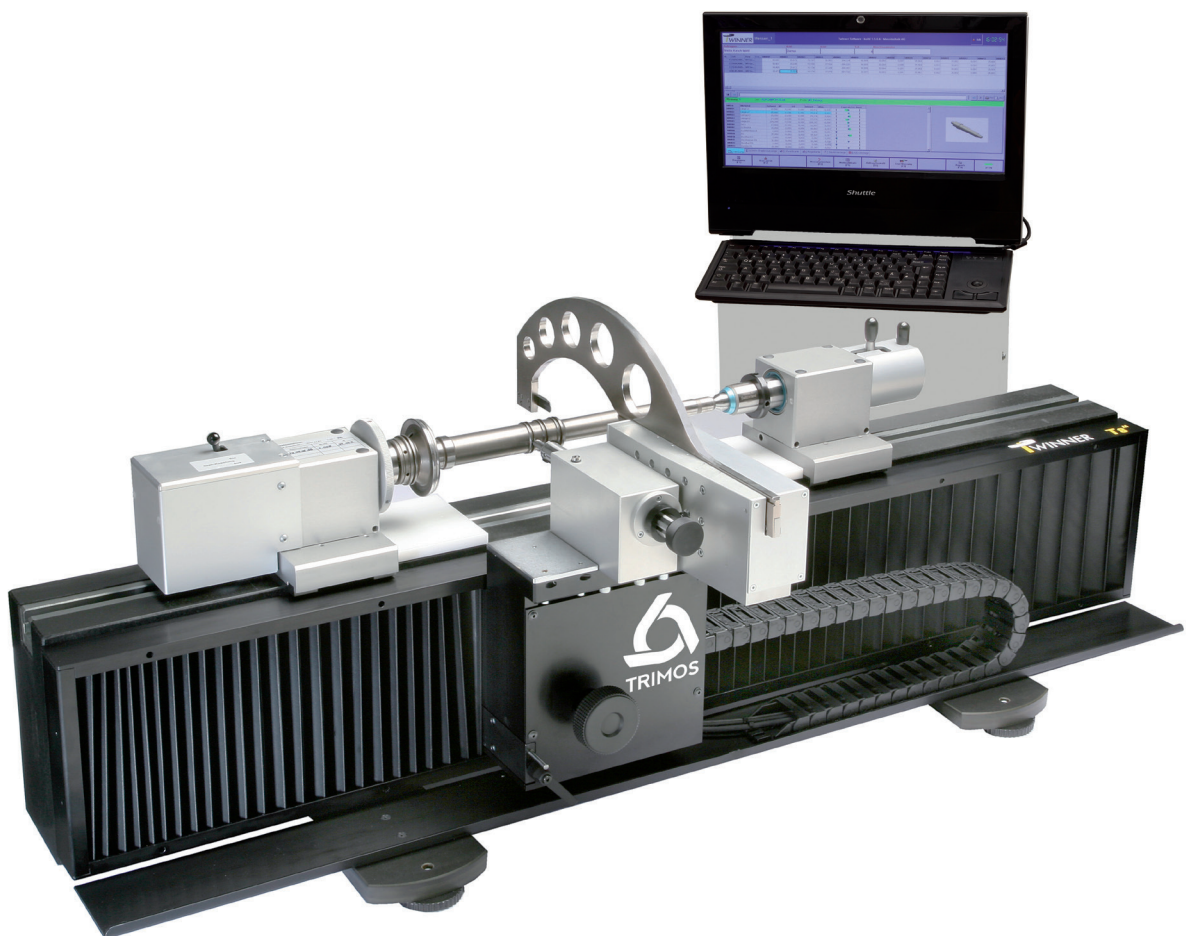

TWINNER

INTRODUCTION

TWINNER is a universal instrument for the measurement of cylinder-shaped parts, which replaces a great number of conventional instruments in the workshop. This measuring centre, multifunctional, flexible and mobile, allows to measure and document practically all that is manufactured by turning.

This instrument has been specifically developed for the workshop and lends itself perfectly to a use in production, close to the machining centre.

TWINNER allows the quality control of sole parts as well as that of small batches. Other areas of use are the control and acceptance of machine tool. All revolution parts can be precisely measured, without adjustment necessary. The range of parts that can be measured spreads over typical turning parts, such as axles, gearbox shafts, camshafts, crankshafts, transmission shafts, joints and revolving parts, to parts with very elaborate geometry.

TWINNER is available in the following dimensions: lengths of 400, 800, 1200 and 2000 mm and diameters of 125 or 160 mm. The manual use and control of the TWINNER are performed by a PC with TWINNER soft.

BUILT FOR WORKSHOP USE

VERY SIMPLE HANDLING

USE WITHOUT PRELIMINARY KNOWLEDGE

NO USER'S INFLUENCE THANKS TO A CONSTANT MEASURING FORCE

























EXCELLENT REPEATABILITY

VERY FAST CHANGE OF PART

EASY CALIBRATION

COMPLETE SELECTION OF ACCESSORIES

DESCRIPTION

- | | | |
|---|---|---|
|  Length |  External diameter |  Shoulder |
|  Diameter on odd division |  Width of internal recess |  Width of external recess |
|  Diameter of recess |  Width of chamfer |  Internal distance |
|  Internal depth |  Angle of taper |  Coaxiality |
|  Concentricity |  Axial run-out |  Interrupted axial run-out |
|  Axial run-out to part axis |  Position |  Radius |
|  Eccentricity |  Eccentricity to part axis |  Interrupted eccentricity |
|  Radial run-out to part axis |  Point of intersection |  Angular pitch |
|  Pitch | | |



Typical parts easily measured with a Twinner.

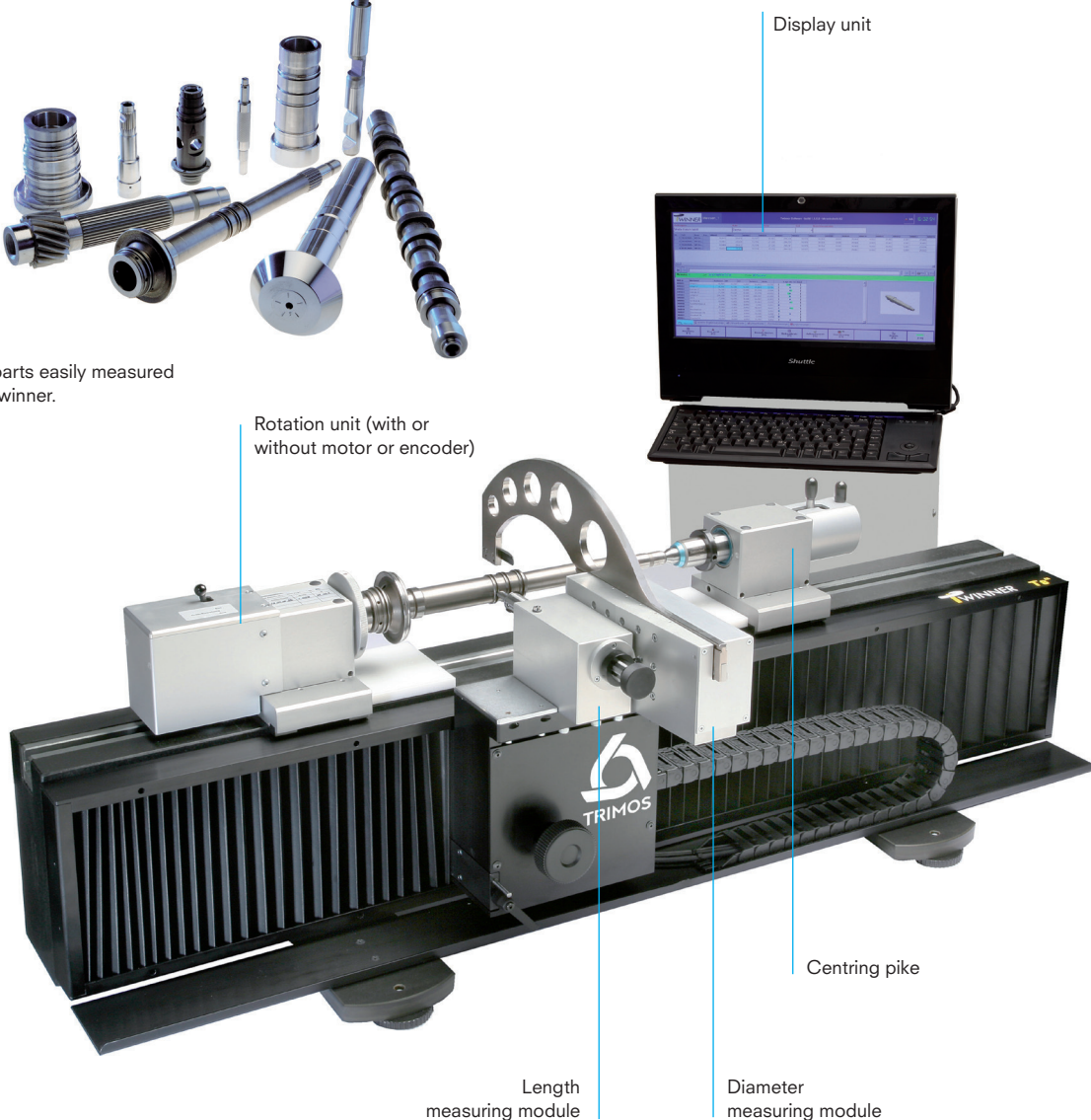

TWINNER

DISPLAY / SOFTWARE

The Twinner instruments are controlled by a PC system with different hardware and software modules:

- TWINNER master-easy
- TWINNER master-pro
- TWINNER premium-easy
- TWINNER premium-pro

HARDWARE

MASTER:

WITHOUT ENCODER, DIAMETER MODULE WITH 1 MEASURING SYSTEM

PREMIUM:

WITH ENCODER, DIAMETER MODULE WITH 2 MEASURING SYSTEMS

SOFTWARE

TWINNER SOFT EASY:

FREE MEASUREMENT (NO SEQUENCES)

MEASURING REPORTS

INDIVIDUAL MACROS

TWINNER SOFT PRO:

FREE MEASUREMENT

TEST SEQUENCES WITH USER GUIDE

TEACH-IN

STATISTIC

NETZWERKANBINDUNG

RECORDING OF RESULTS IN IN Q-DAS

MEASURING REPORTS

OPTICAL MODULE (OPTIONAL)

Ideal for the measurement of tiny details such as grooves, angles, chamfers etc.



DISPLAY / SOFTWARE

TWINNER SOFT PRO

For better comfort and more functionality, the TWINNER can be equipped with TWINNER soft Pro. This modern SPC system offers unbeatable value for money. Its flexibility makes it adaptable to the most diverse measuring situations.

USE OF PROGRAM ADAPTED TO THE WORKSHOP

MEASURING GRAPHICAL HELP

MEASURING MACROS

FREELY CONFIGURABLE VIEWS

REPORTS AND MEASUREMENT GRAPHS

MODERN AND CONVENIENT SPC SYSTEM

FUNCTIONS ADMINISTRATION BY USERS AND PASSWORDS

RECORDING OF RESULTS IN ASCII FORMAT IN Q-DAS

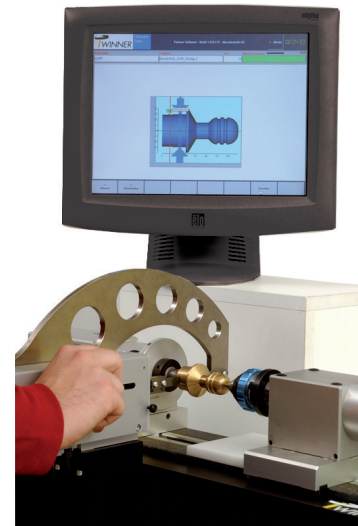

TWINNER Soft Pro considerably reduces the programming time of a measuring sequence and allows a rational use of the instrument.

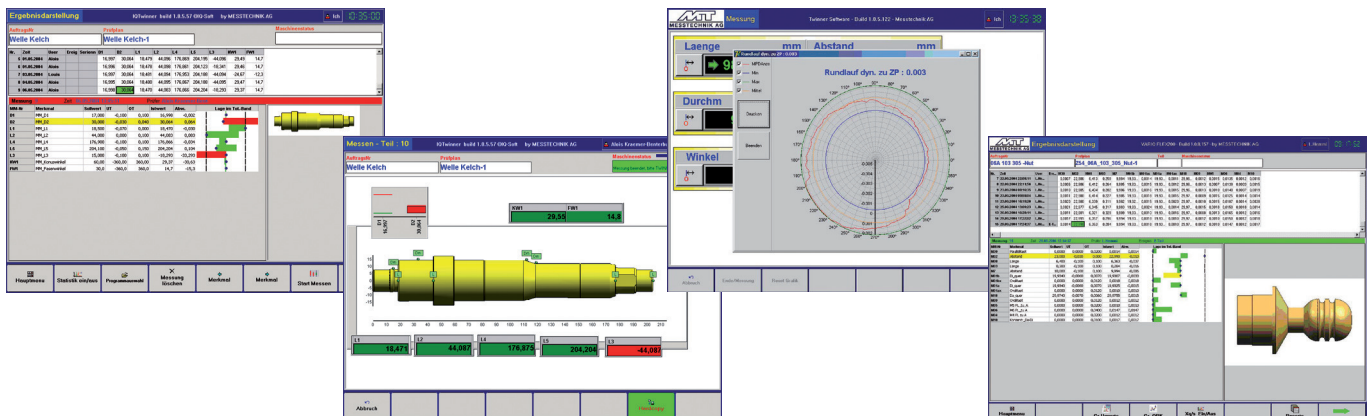

Numerous functions are integrated into the software:

- Freely configurable masks, reports and graphs
- Administration of functions by users and passwords
- Recording of results in ASCII format in Q-DAS

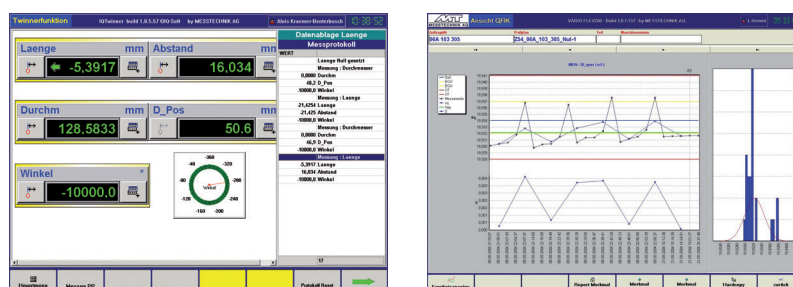

TWINNER

TECHNICAL SPECIFICATIONS

Twiner		T4M	T8M	T12M	T20M
Measuring range, length X	mm (in)	400 (15)	800 (31)	1200 (47)	2000 (78)
Measuring range, diameter Y	mm (in)	125 (5)	125 / 160 (5/6)		
Max. permissible errors, length X ¹⁾	µm	3 + L(mm) / 100			
Max. permissible errors, diameter Y ¹⁾	µm	1.5 + D(mm) / 100			
Repeatability, length X (2s) ¹⁾	µm	≤ 2.0			
Repeatability, diameter Y ¹⁾	µm	≤ 1.0			
Resolution, length X	mm	0.001 / 0.0001			
Resolution, diameter Y	mm	0.001 / 0.0001			
Measuring force, length and diameter	N	2.0			
Max. part weight	kg	20 / 100			
Weight (instrument)	kg	120	140	180	240

¹⁾ Values valid at temperature of 20 ± 0.2 °C and relative humidity of 50 ± 5%.

SCHEMA

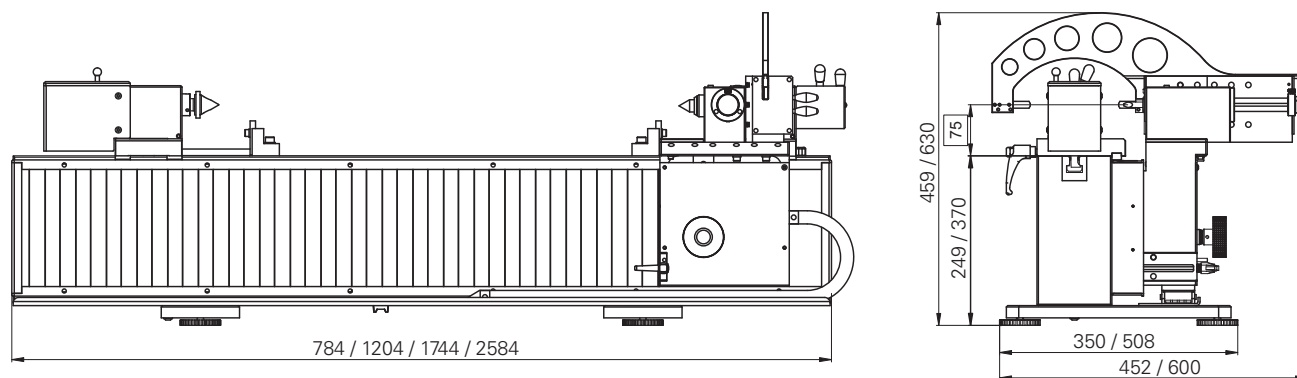

STANDARD INSTRUMENT

The Twinner instruments are supplied as follows:

- Instrument according to specifications
- PC with corresponding hardware and software equipment (see next page)
- User's manual
- Test certificate
- Declaration of conformity

CODE NUMBER

Twinner	PC equipment
T4 Master-Easy 700 215 10 12	Twinner T4 without encoder, 1x Diameter-Modul, free measurement
T4 Master-Pro 700 215 10 13	Twinner T4 without encoder, 1x Diameter-Modul, Sequences
T4 Premium-Easy 700 215 10 14	Twinner T4 with encoder, 2x Diameter-Modul, free measurement
T4 Premium-Pro 700 215 10 15	Twinner T4 with encoder, 2x Diameter-Modul, Sequences
T8 Master-Easy 700 215 20 12	Twinner T8 without encoder, 1x Diameter-Modul, free measurement
T8 Master-Pro 700 215 20 13	Twinner T8 without encoder, 1x Diameter-Modul, Sequences
T8 Premium-Easy 700 215 20 14	Twinner T8 with encoder, 2x Diameter-Modul, free measurement
T8 Premium-Pro 700 215 20 15	Twinner T8 with encoder, 2x Diameter-Modul, Sequences
T12 Master-Easy 700 215 30 12	Twinner T12 without encoder, 1x Diameter-Modul, free measurement
T12 Master-Pro 700 215 30 13	Twinner T12 without encoder, 1x Diameter-Modul, Sequences
T12 Premium-Easy 700 215 30 14	Twinner T12 with encoder, 2x Diameter-Modul, free measurement
T12 Premium-Pro 700 215 30 15	Twinner T12 with encoder, 2x Diameter-Modul, Sequences
T20	Twinner T20 (on request, other models T16, T25, etc.)

The models above are supplied with granite base and PC for corresponding measuring systems and software. Diameter modules, length modules, measuring inserts, location centers etc. must be selected separately from the accessory list.

SPECIFIC MODELS

Trimos offers specific solutions adapted to all applications for measurement of cylinder-shaped parts and revolving parts. For more information, your local Trimos agent remains at your disposal.

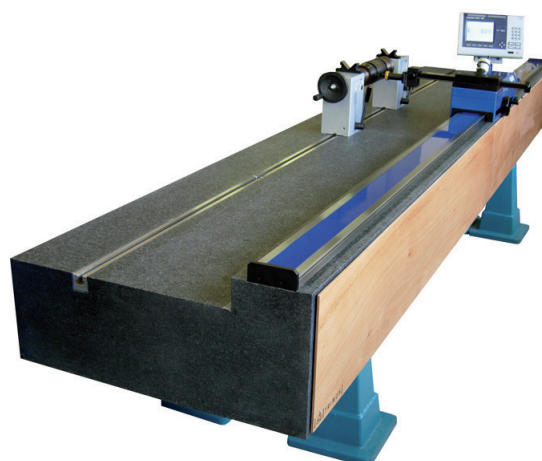

TWINNER

APPLICATIONS

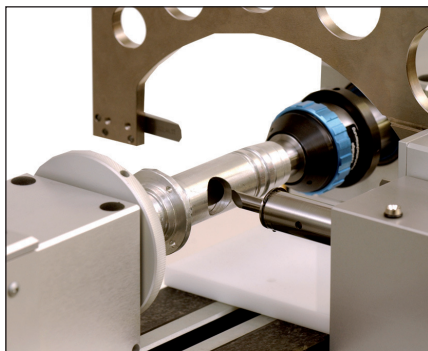

Centerline measurement

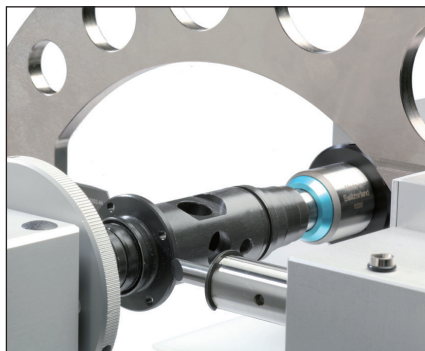

Length measurement

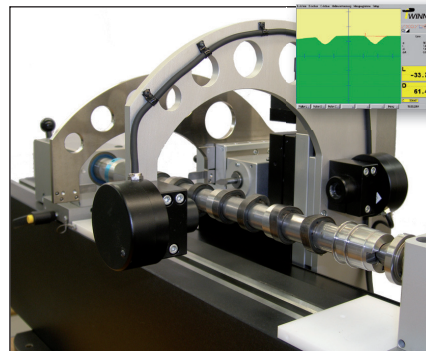

Optical measurement of the characteristics of a camshaft

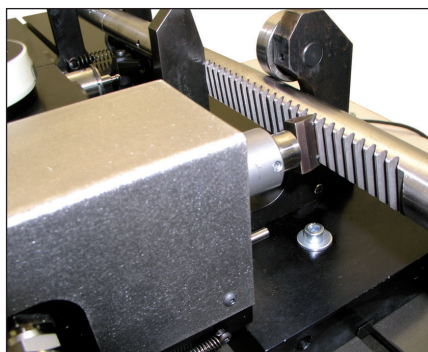

Measurement of rack rail teeth inclination (specific design)

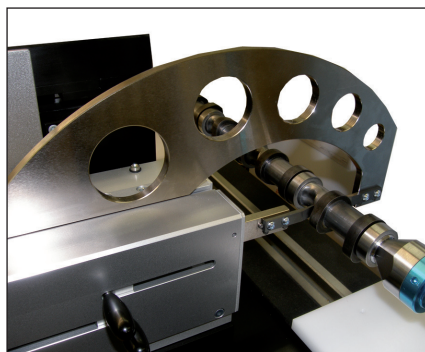

Diameter measurement on a camshaft

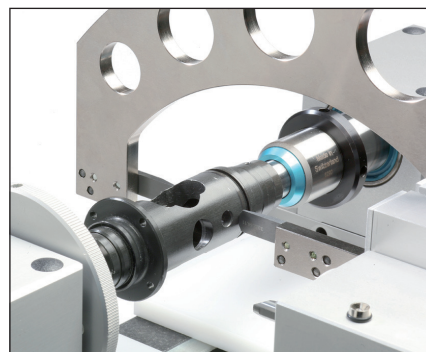

Diameter measurement in a groove



Positions measurement (specific design)

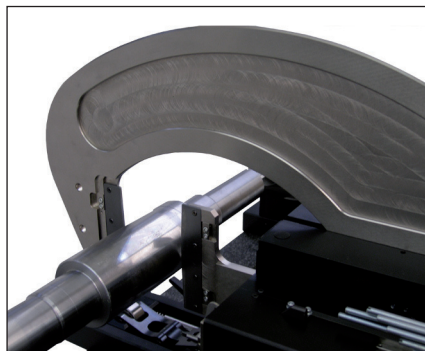

Installation for eccentric diameter measurement (specific design)

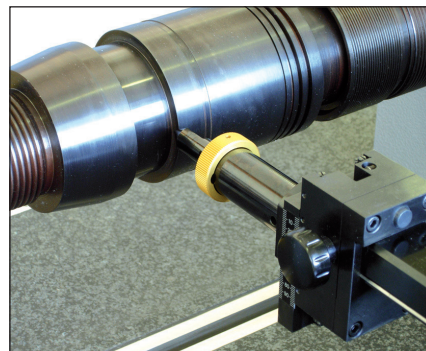

Length measurement for large parts (specific design)